

WARNING!!

The attached Gold Medal Manual is for reference only and is not intended for any other purpose. The information contained in these on line manuals is subject to change at any time. Improvements are always being made to Gold Medal equipment and this information may not be the latest available for your purposes. It is critical that you call Gold Medal Products technical service department at 1-800-543-0862 for any questions about machine operations, replacement parts, or any service questions. Neither Gold Medal nor Phil Erb Concessions represent that these on line manuals contain the most current information available for the product represented.

G-Whiz Gas Popper

Instruction Manual Model #5908

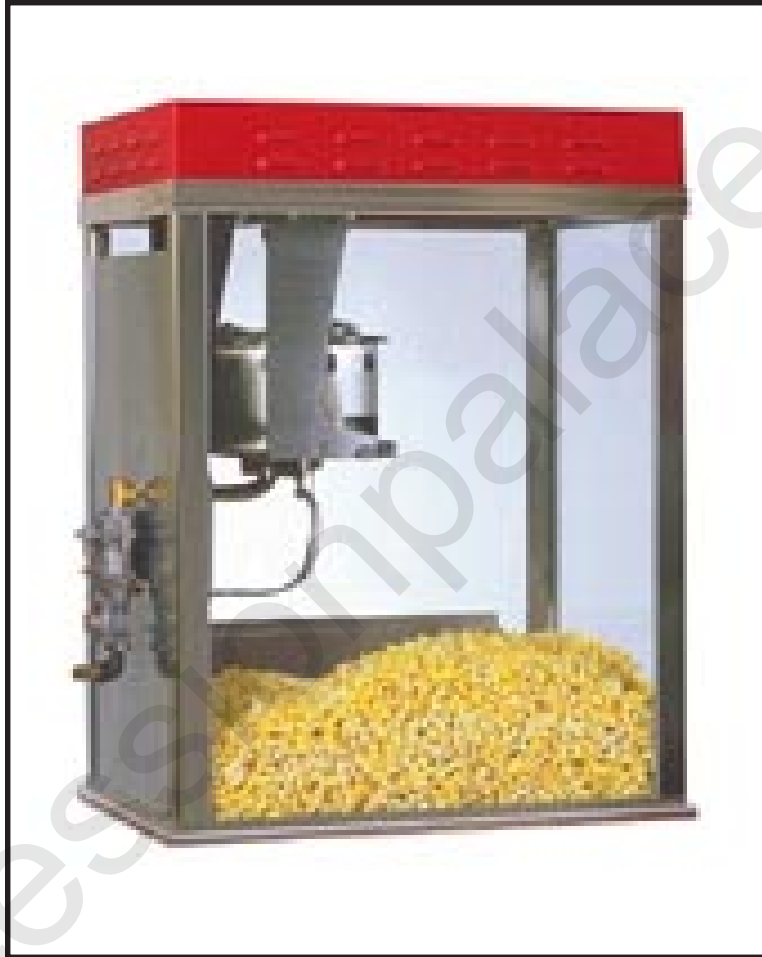



 **GOLD MEDAL**[®]
FUNFOOD EQUIPMENT & SUPPLIES

Cincinnati, OH 45241-4807 USA

GAS SAFETY PRECAUTIONS

	▲ WARNING
	Instructions on what to do when a user smells gas can be obtained from the local gas supplier. These instructions must be posted in a prominent location where the unit is to be operated.

	▲ WARNING
	Do NOT store or use gasoline or other flammable vapors and liquids in the vicinity of this or any other appliance.

	▲ WARNING
	Improper installation, adjustment, alteration, service or maintenance can cause property damage, injury, or death. Read the Installation, Operating and Maintenance Instructions thoroughly before installation or servicing this equipment.

	▲ WARNING
	Keep this appliance free and clear of combustibles. Do NOT obstruct the flow of combustion and ventilation airways.

NOTE

The wiring diagram is located under the dome of the machine, next to the drive motor.

NOTE

The information, specifications and illustrations contained in this manual represent the latest data available at time of publication. Right is reserved to make changes as required at the discretion of Gold Medal Products Company without notice.

SAFETY PRECAUTIONS

	⚠ CAUTION
	<p>This equipment is designed and sold for commercial use only. This equipment is not to be used by the consumer in home use. Do not allow direct contact of this equipment by the public when used in food service locations. Only personnel trained and experienced in the equipment operation may operate this equipment. Carefully read all installation instructions before operating the equipment.</p>

	⚠ WARNING
	<p>Always wear safety glasses when servicing this equipment.</p>

	⚠ WARNING
	<p>To avoid serious burns, do NOT touch the kettle while it is hot.</p>

	⚠ WARNING
	<p>Any alterations to this equipment will void the warranty and may cause a dangerous situation. NEVER make alterations to the equipment. Make sure all machine switches are in the OFF position before plugging the equipment into a receptacle.</p>

	⚠ DANGER
	<p>Machine must be properly grounded to prevent electrical shock to personnel. Do NOT immerse the kettle, warmer, or any other part of this equipment in water. Always unplug the equipment before cleaning or servicing.</p>

NOTE

The information, specifications and illustrations contained in this manual represent the latest data available at time of publication. Right is reserved to make changes as required at the discretion of Gold Medal Products Company without notice.

INSTALLATION

This instruction booklet is very thorough and complete. Please take the time to read this entire booklet before attempting to operate the appliance.

Your 12 Oz. commercial popper is the finest 12 Oz. Gas Popper ever built. No expense has been spared to give you a long lasting unit to withstand the heavy loads of commercial popping. The special kettle is extra-heavy to prevent burnouts or warping and is made from excellent heat conducting aluminum.

UNPACKING AND ASSEMBLY

After unpacking your 12 Oz. Gas Popper, set it on a counter where you intend to use it and remove all tape. Make sure clearances around the appliance comply with the marking on the data plate for the location you have selected. Bolt the Popper to the counter to secure it from tipping. Use the drilling template below for proper hole alignment.

GAS INSTALLATION

When installing your new 12 Oz. commercial Gas Popper, you must conform with local codes or in the absence of local codes, with the National Fuel Gas Code, ANSI Z223.1-1992 or latest edition.

	⚠ DANGER
	Gas is safe when used properly, but can be very dangerous when used improperly. We suggest that installation be carefully made by qualified personnel only. Gas companies have competent service personnel to provide safe installation.

When selecting a combustible and noncombustible location for your new 12 Oz. Gas Popper, pay close attention to the installation clearances. The minimum clearance for the side (rear) opposite the dump handle is 10 inches. The minimum side clearance is 30 inches. Suitable for installation on combustible counters.

The appliance and its individual shutoff valve must be disconnected from the gas supply piping during pressure testing of the system in excess of 1/2 psig (3.45 kpa). During any pressure testing of the gas supply piping system at pressures equal to or less than 1/2 psig (3.45 kpa), the appliance must be isolated from the gas supply piping system by closing its individual manual shutoff valve. **NOTE:** Be sure to provide adequate air supply and adequate clearance for air openings into the combustion chamber. Be sure to provide adequate clearances for servicing and proper installation.

After installation, all gas connections must be checked for leaks with a soap solution

	⚠ DANGER
	Do not use a match or flame to check for leaks - you may cause a fire or explosion! When gas connections are complete, wire the unit to a power source which will carry the current specified on the units data plate.

ALTITUDE RANGE

The factory has sized the burner orifices for an elevation up to 2000 feet above sea level. For high altitude operation contact gold medal customer service department.

GAS PRESSURE

We have determined that optimum popping occurs when the gas pressure is adequate. For propane gas we recommend a manifold pressure setting of 10 inches of water column (6 oz/sq in). The pressure is measured at the appliance while the main burner is ignited. Follow instructions in the maintenance and repair section of this instruction manual. Adequate gas requirements are maintained by proper pipe sizing. Be sure to use properly sized pipe to supply the needed pressure.

LIGHTING AND SHUT-DOWN INSTRUCTIONS

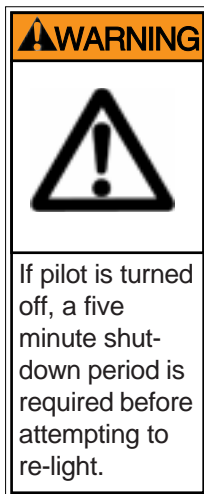

1. Turn the gas safety valve handle to the "PILOT" position.
2. Push down safety valve reset button and hold a match to the pilot burner. Repeat until pilot lights. Continue holding the reset button for 30-45 seconds, until the pilot remains burning when the button is released.
3. Turn the gas safety valve handle to the "ON" position. The main burner should now ignite from the pilot burner.
4. Should you want to turn both the pilot and main burner off, pull the gas safety valve and turn the handle to the "OFF" position.

TO MAKE POPCORN

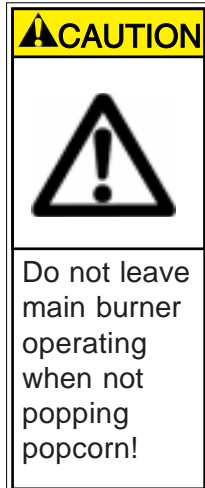

Turn the main burner on. Put oil in the kettle. You may let oil heat in kettle before adding popcorn and salt. We recommend 12 ounces of corn, 4 ounces of high quality coconut oil and Flavacol salt to get the best results. An accurate measure of oil and flavacol is the secret to great tasting popcorn, popcorn that brings back repeat customers. If you are in a commercial pre-pop operation, this is even more important. Good quality popcorn commands a high price, and to your customer it is well worth the slightly higher price.

You may put more popcorn into the kettle, but this will lengthen the popping cycle and your overall production will decrease. You can make smaller batches if necessary, but always use a corn to oil ratio of 3:1. Also, when making small batches, or in between batches, you may want to turn the main burner flame down to prevent it from getting too hot.

IF THE FLAME GOES OUT

A five minute shut down period is required before attempting to re-light.



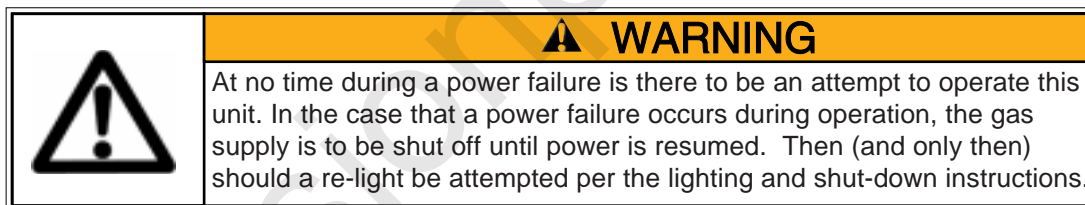

1. Check to see if you are out of gas.
2. Check to see if the thermocouple is in proper position.



TO CLEAN KETLE

Unplug machine before cleaning. In order to keep your popper working efficiently, wipe the inside of the kettle with a damp cloth. There is no need to clean using a detergent, since this will only remove the oil.

MAINTENANCE INSTRUCTIONS

	<p style="text-align: center;">⚠ CAUTION</p> <p>THE FOLLOWING SECTIONS OF THIS MANUAL ARE INTENDED ONLY FOR QUALIFIED SERVICE PERSONNEL WHO ARE FAMILIAR WITH ELECTRICAL EQUIPMENT. THESE ARE NOT INTENDED FOR THE OPERATOR.</p>
	<p style="text-align: center;">⚠ WARNING</p> <p>Do NOT perform and service or repairs on this equipment. Contact our factory, a sales representative, or your local service company for service or repairs.</p>
	<p style="text-align: center;">⚠ WARNING</p> <p>Adequate eye protection must be used when servicing this equipment to prevent the possibility of injury.</p>
	<p style="text-align: center;">⚠ DANGER</p> <p>Do NOT immerse the kettle, warmer, or any other part of this equipment in water.</p>

ORDERING SPARE PARTS

1. Identify the desired part by checking it against the photos, illustrations, and/or the parts list.
2. When ordering, please include part number, part name, and quantity desired.
3. Please include your model name and machine serial number (located on the machine nameplate) with your order.
4. Address all parts orders to:

Parts Department
Gold Medal Products Co.
10700 Medallion Drive
Cincinnati, Ohio 45241-4807

or, place orders at:

(513) 769-7676
Fax: (513) 769-8500
E-mail: goldme19@eos.net

KETTLE ASSEMBLY

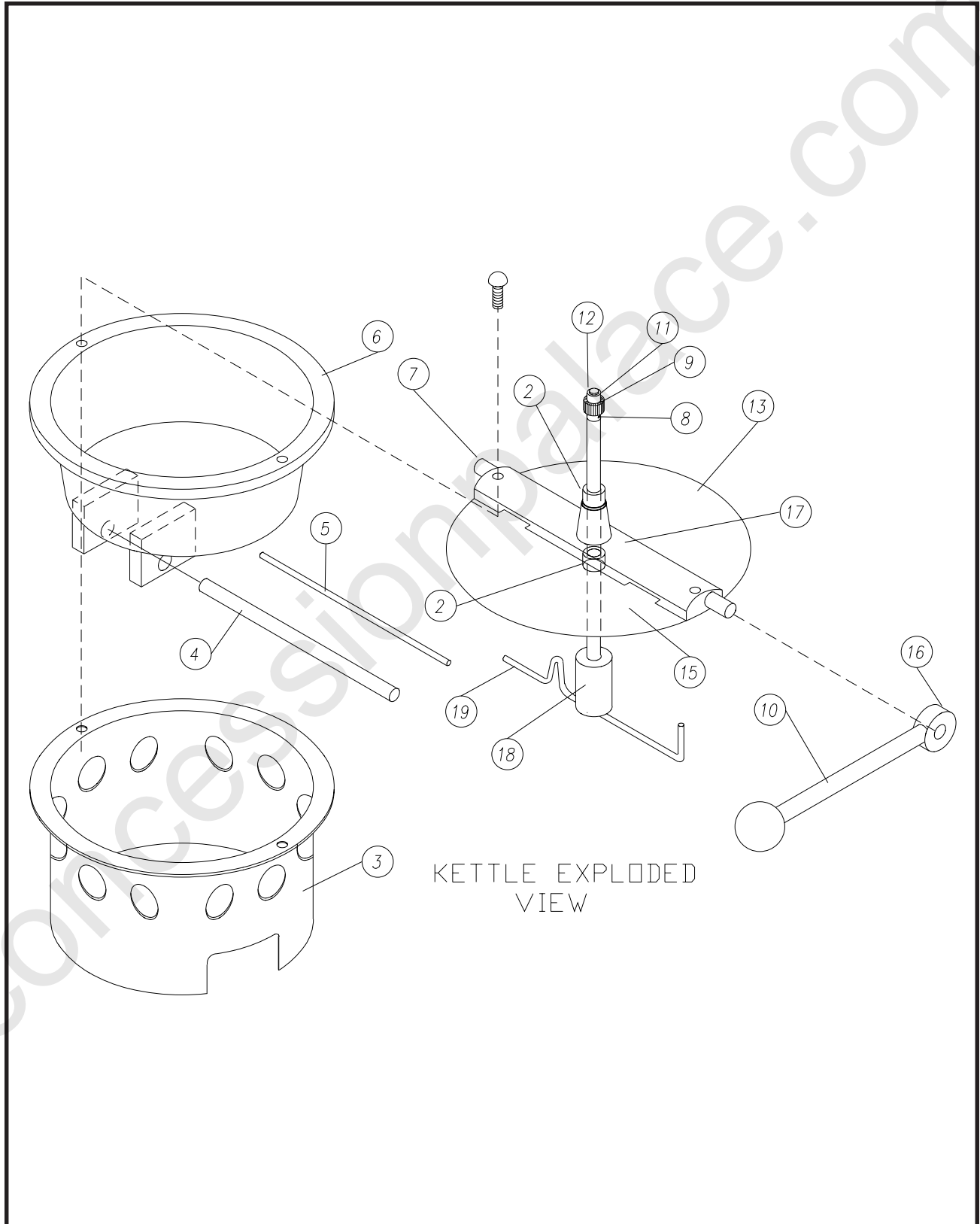

KETTLE ASSEMBLY

Item No.	Part No.	Description
1	74870	Whole Kettle Assembly
2	47326	Set Collar, ½" I.D. x 7/8" O.D.
3	74852	Kettle Heat Shroud
4	74859	Kettle Stop Rod
5	74863	Kettle Pivot Rod
6	74865	Kettle Weldment
7	74868	Agitator / Lid Assembly
8	41742	Set Screw (10-32 x 3/16")
9	47059	Spur Gear
10	47102	Dump Handle Assembly
11	47106	Needle Bearing
12	47107	C-ring
13	47119	Kettle Lid, Rear
14	47296	Lid Lifter Knob
15	47720	Kettle Lid, Front
16	47751	Set Screw
17	61025	Crossbar Assembly
18	61093	Agitator Weight
19	74869	Agitator Shaft Weldment

CABINET ASSEMBLY

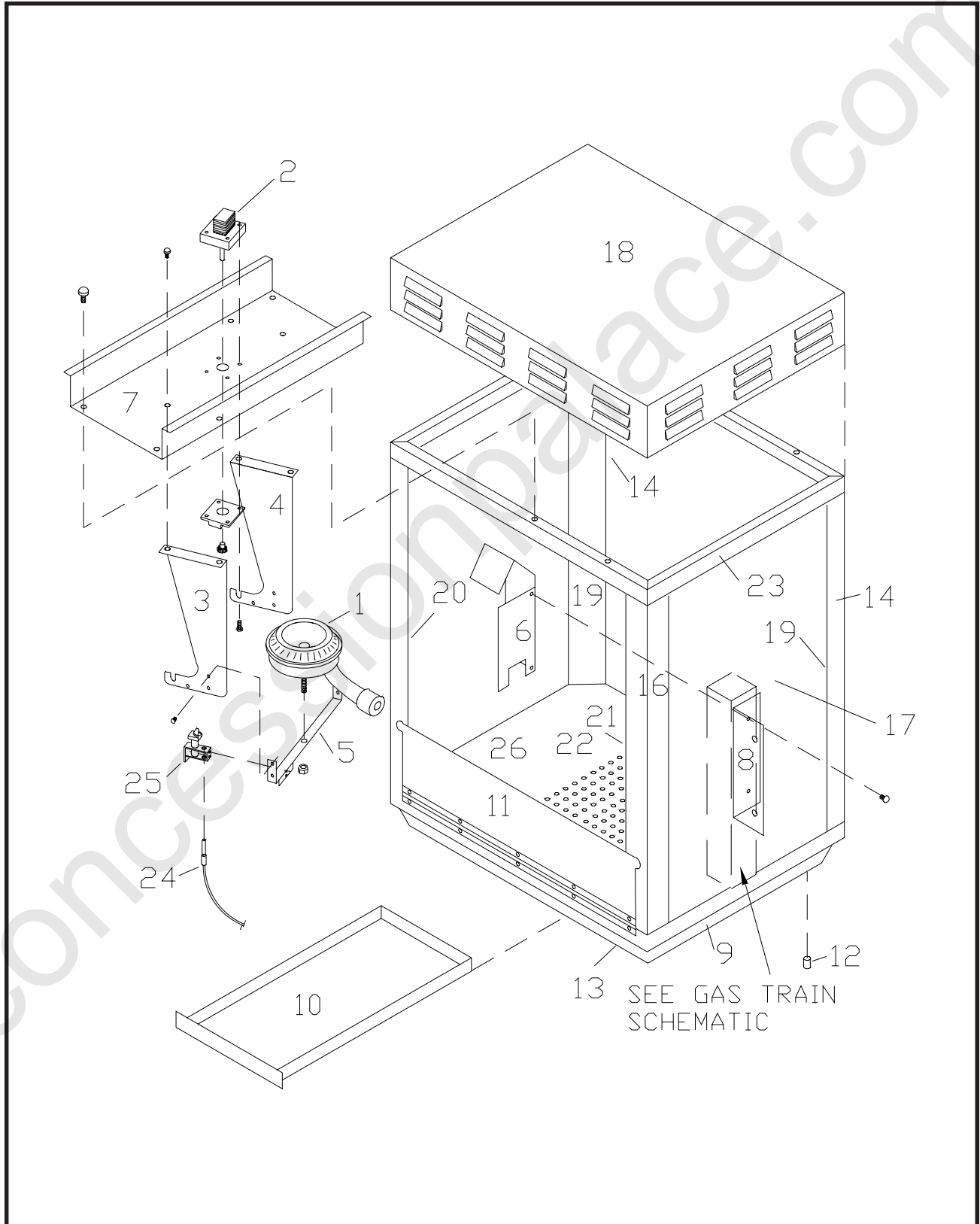

CABINET ASSEMBLY

Item No.	Part No.	Description
1	74547	Burner
2	74576	12V D.C. Motor
3	74854	Hanger Arm, Left
4	74855	Hanger Arm, Right
5	74857	Burner Mounting Bracket
6	74858	Burner Shroud
7	74856	Motor Plate
8	74860	Bracket, Gas Train Mounting
9	47002	Bottom Extrusion Frame Assembly
10	47003	Old Maid Pan
11	47006	Drop Panel Assembly
12	47238	Glide
13	47389	Bottom Cover
14	49351	Front Corner Post, Bright
15	47065	Kettle Drive Gearbox
16	47059	Drive Gear
17	74861	Mount, Panel
18	74866	Dome
19	77525	Glass Strip
20	77526	Glass Strip
21	77529	Glass Strip
22	n/a	
23	77732	Top Frame, Anodized
24	57030	Thermocouple
25	57031	Pilot Burner
26	47165	Corn Pan

GAS BURNER ASSEMBLY

Item No.	Part No.	Description
1	57030	Thermocouple
2	57031	Pilot Burner
3	74027	Gas Safety Valve
4	74050	Pilot Orifice, .010"
5	74115	Pressure Regulator
6	74560	"T" Fitting
7	74561	¼" Aluminum Tubing
8	74568	Fitting, Brass Orifice
9	89694	Lighter Tube Orifice
10	74558	Burner
11	74884	1/8" NPT x 1½" Nipple
12	74885	Coupling

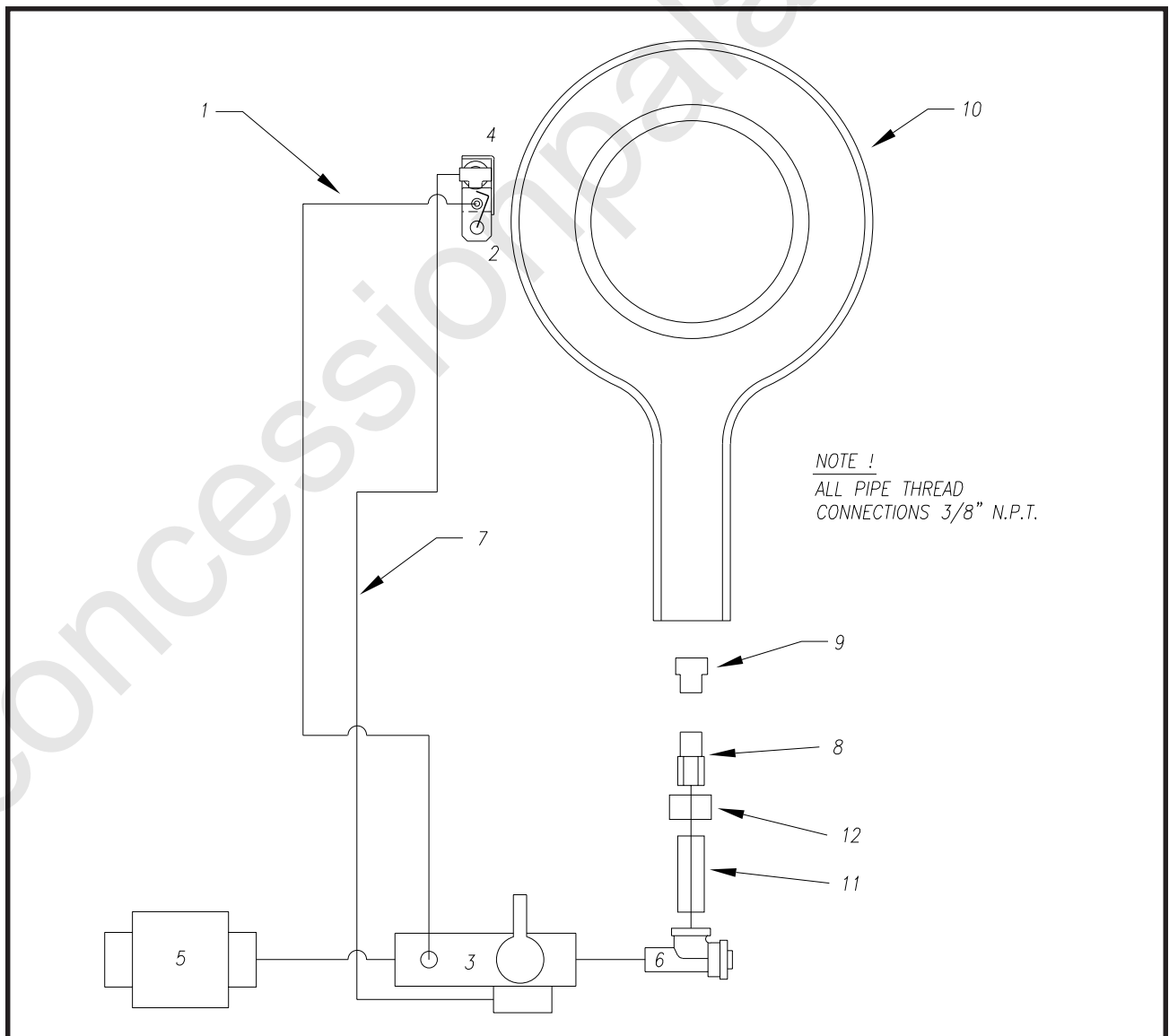

WARRANTY

WE WARRANT to the original purchaser the Gold Medal equipment sold by us to be free from defects in material or workmanship under normal use and service. Our obligation under this warranty shall be limited to the repair or replacement of any defective part for a period of six (6) months from the date of sale to the Original Purchaser with regard to labor and two (2) years with regard to parts and does not cover damage to the equipment caused by accident, alteration, improper use, voltage, abuse, or failure to follow instructions.

THIS WARRANTY IS IN LIEU OF ALL OTHER WARRANTIES EXPRESSED OR IMPLIED, AND OF ALL OTHER OBLIGATIONS OR LIABILITIES ON OUR PART, INCLUDING THE IMPLIED WARRANTY OF MERCHANTABILITY. THERE ARE NO WARRANTIES WHICH EXTEND BEYOND THE DESCRIPTION ON THE FACE HEREOF. We neither assume, nor authorize any other person to assume for us, any other obligation or liability in connection with the sale of said GOLD MEDAL equipment or any part thereof.

The term "Original Purchaser" as used in this warranty shall be deemed to mean that person, firm, association, or corporation who was billed by the GOLD MEDAL PRODUCTS COMPANY, or their authorized distributor for the equipment.

THIS WARRANTY HAS NO EFFECT AND IS VOID UNLESS THE ORIGINAL PURCHASER FIRST CALLS GOLD MEDAL PRODUCTS COMPANY AT 1-800-428-2676 TO DISCUSS WITH OUR SERVICE REPRESENTATIVE THE EQUIPMENT PROBLEM, AND, IF NECESSARY, FOR INSTRUCTIONS CONCERNING THE REPAIR OR REPLACEMENT OF PARTS.

NOTE: This equipment is manufactured and sold for commercial use only.



GOLD MEDAL PRODUCTS COMPANY
10700 Medallion Drive
Cincinnati, OH 45241-4807 USA